

EC3630 Radiowave Propagation

**ELECTROMAGNETIC RADIATION
HAZARDS**

by Professor David Jenn



Electromagnetic Radiation Hazards (1)

Electromagnetic energy is absorbed by the body and deposits energy internally leading to thermal loads and temperature gradients. Since the 1950s the informally accepted tolerance dose in the US has been 10 mW/cm^2 . The American National Standards Institute (ANSI) officially adopted 10 mW/cm^2 as the standard in 1966 for a five year term, and it was reaffirmed again in 1969 and 1974. It was concluded at the time that power densities in excess of 100 mW/cm^2 were needed to produce any significant biological changes.

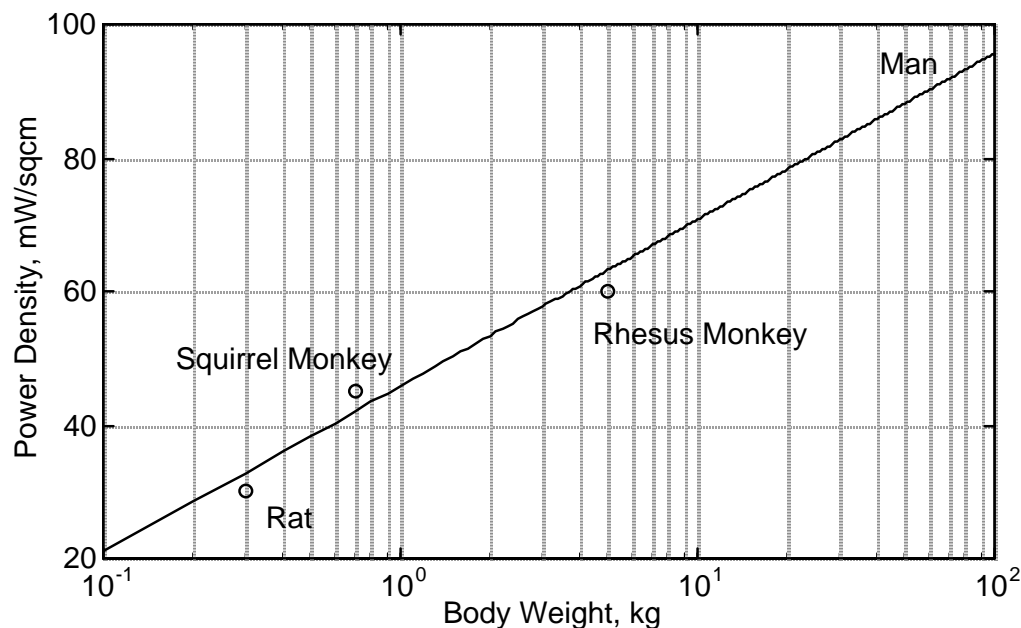

Power density needed for 1° C temperature increase at 2.45 GHz and 60 minutes.

Electromagnetic Radiation Hazards (2)

Later studies revealed that certain body organs were more susceptible to the effects of electromagnetic heating than others. The testis power density safety curve assumes damage when the temperature increases by 1.4 degrees C (which is less than a warm bath).

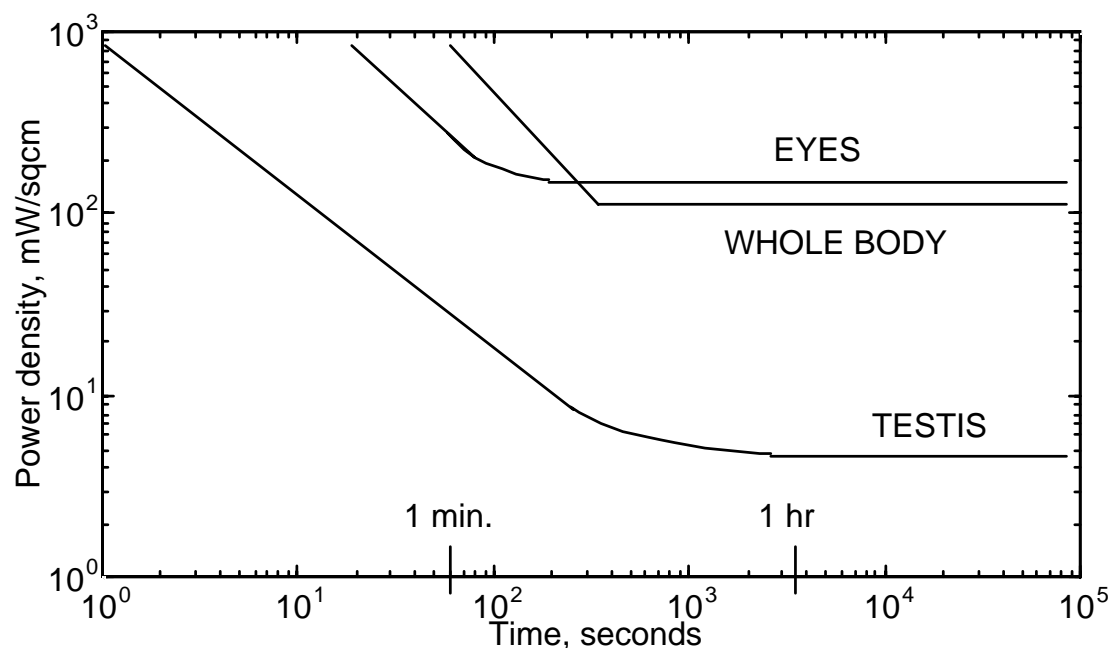

Effects other than those due to heating have been alleged: changes in hormone levels, blood chemistry, neurological function, growth, DNA, etc. The vast majority of studies have been negative. Research on the effect of EM radiation on the immune system has been inconclusive.

Threshold levels versus time for sensitive organs.

Electromagnetic Radiation Hazards (3)

The specific absorption rate (SAR) is used in dosimetric applications

$$\boxed{\text{SAR} = \sigma |\vec{E}|^2 / \rho} \quad \text{W/kg}$$

where ρ is the mass per volume (kg/m^3). SAR is the time rate at which electromagnetic energy is imparted to an element of mass of a biological body.

A linear rise in temperature ΔT can be converted to a SAR value by the formula

$$\boxed{\text{SAR} = c_p \Delta T / \Delta t}$$

where c_p is the specific heat of the material ($\text{J/kg-}^\circ\text{C}$) and Δt is the duration¹.

It was also found that the body has a resonance when the height (head-to-toe length) is approximately 0.4λ and the electric field is parallel to the body axis. This occurs around 70 MHz for the standard man (175 cm). Absorption can increase by a factor of seven at resonance.

¹For water $c_p = 1 \text{ cal/gm-}^\circ\text{C}$, $\rho = 1000 \text{ kg/m}^3$ at 1 atmosphere and 0°C , and $1 \text{ cal} = 4.18606 \text{ J}$.

Electromagnetic Radiation Hazards (4)

Summary of current ANSI standards for exposure to non-ionizing radiation

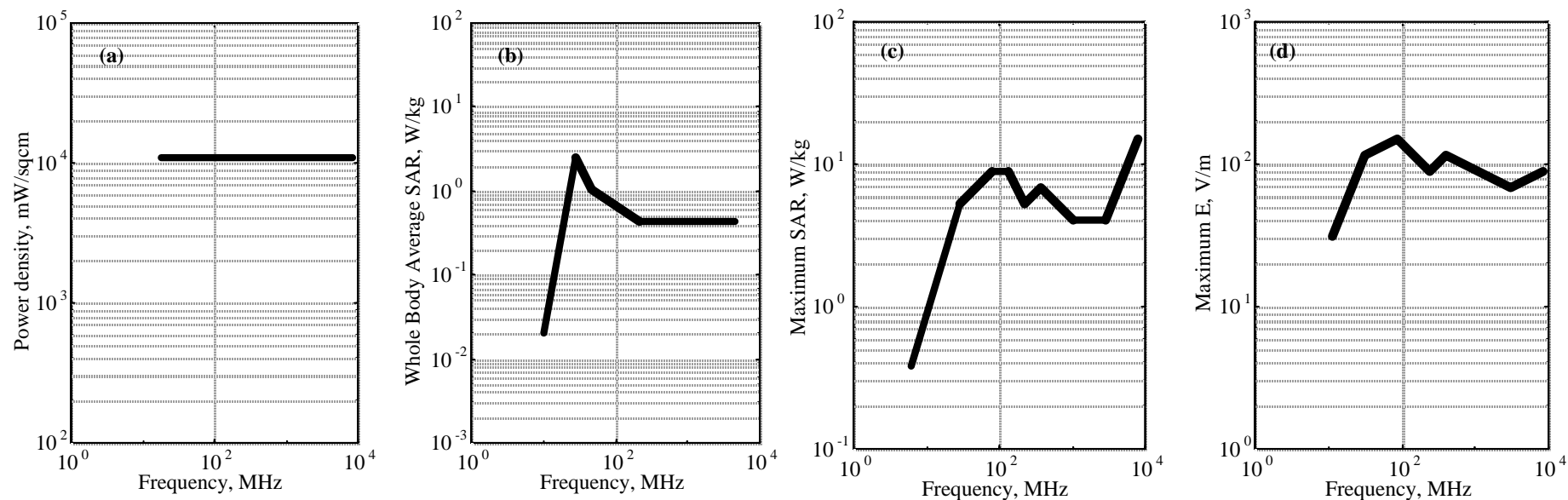

Data has shown that a whole-body averaged SAR of 4 W/kg is acceptable, and subsequently the standard was set at 0.4 W/kg to incorporate an order of magnitude safety factor. The standard allows the spatial peak SAR to be greater than the whole-body averaged SAR by a factor of 20. Essentially this allows relaxation of the power density limits for partial body exposure. The maximum permissible exposure (MPE) in the 1 to 3 GHz range is based on a 6 minute averaging time.

Electromagnetic Radiation Hazards (5)

The safety issue has four aspects:

1) The whole-body averaged SAR should be less than the safe level (4 W/kg)

The whole-body averaged SAR is computed taking the average power absorbed by the body over a 6 minute interval and dividing by the total body weight.

2) The maximum partial-body SAR should be less than 20 times the whole-body averaged SAR (80 W/kg)

Partial-body SAR is permitted to be up to 20 times larger than the whole-body averaged SAR. It is determined by averaging over a volume (V_a) exposed to the strongest incident power density. The appropriate averaging volume is still the subject of discussion. Cubes of 1 cm³, 10 cm³, and 100 cm³ have been suggested.

3) The power density versus exposure time should remain below the safe values for sensitive organs such as the eyes and testes.

The traditional safety standard of 10 mW/cm² applies to an indefinite time of exposure. It has been recognized that much higher levels are tolerable over short time periods. The most sensitive organ is the testes and the curve shown previously is based on the time and power density to reach 37 C, which is considered potentially dangerous. However this temperature is exceeded in a common hot bath and thermal induced damage is generally reversible. Irreversible injury to the human eye can occur when the exposure reaches several hundred mW/cm² and there are multiple exposures of several minutes in duration. Extended exposures in excess of 10 mW/cm² but less than 300 mW/cm² can cause reversible injuries.

4) The incident power density must be low enough to avoid a shock or burn hazard.

Current induced in the body can potentially lead to shock if contact is made with a conducting object.

Electromagnetic Radiation Hazards (6)

The depth of penetration into and subsequent absorption of a wave by the body are determined by the relative dielectric constant (ϵ_r) and conductivity (σ) of the body tissues. These are shown as a function of frequency. The absorption of energy is determined by the attenuation constant, α .

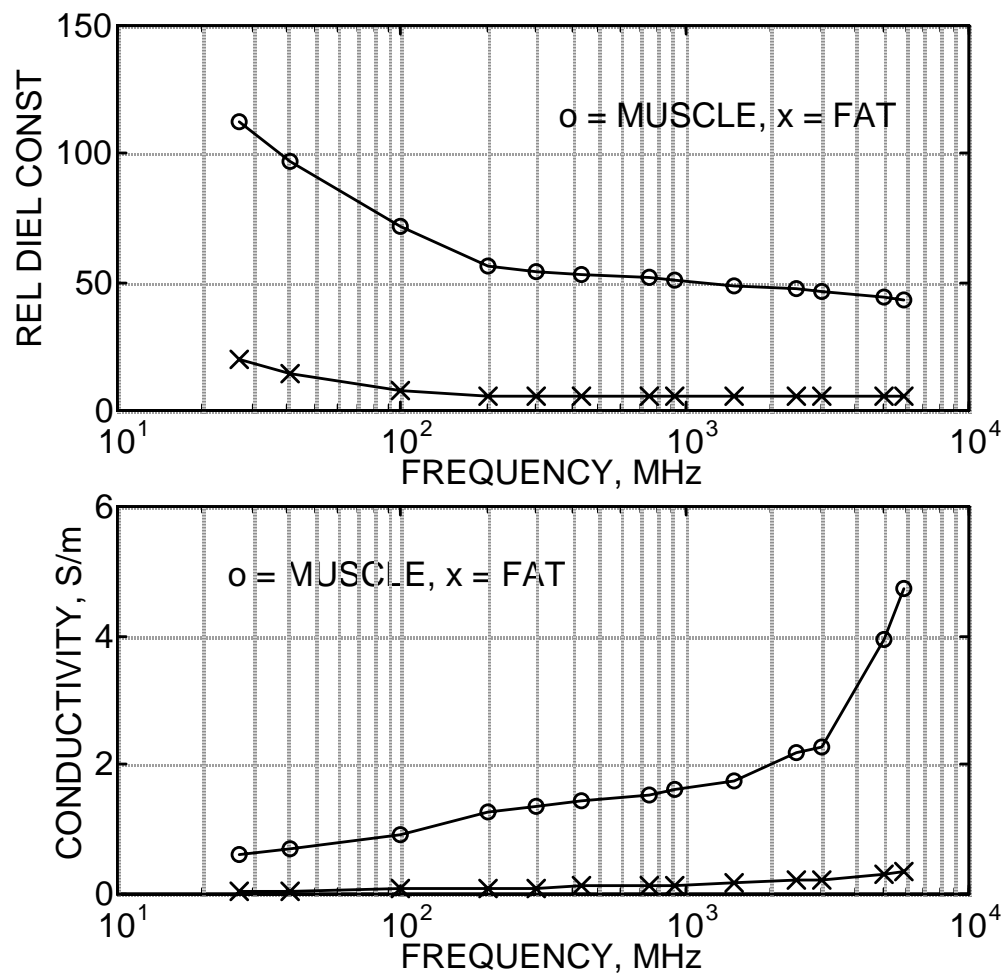

Electromagnetic Radiation Hazards (7)

Because the body is a good conductor, the skin depth is $\delta \approx 1/\alpha$. The relatively large ϵ_r and σ of the body results in a significant reflection of the incident wave at the body/air boundary.

Skin depth of body materials

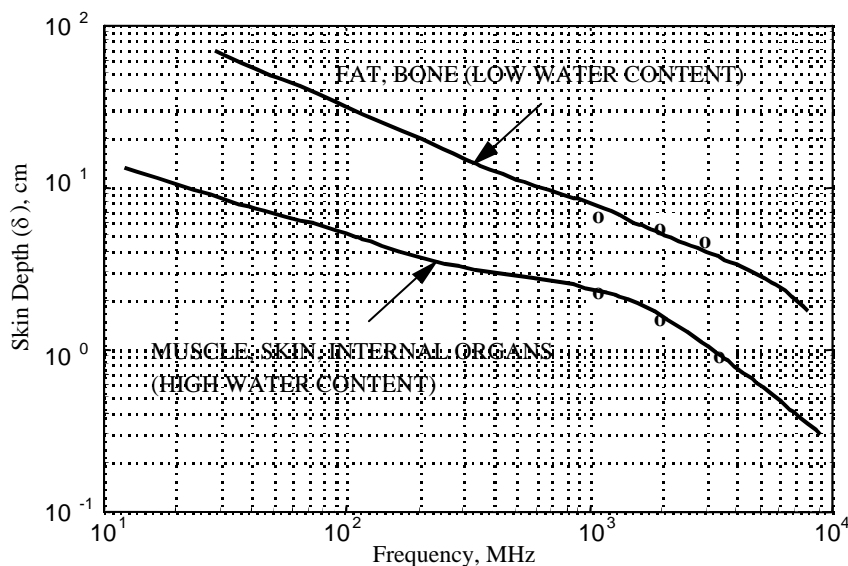

Reflection of a plane wave from the body

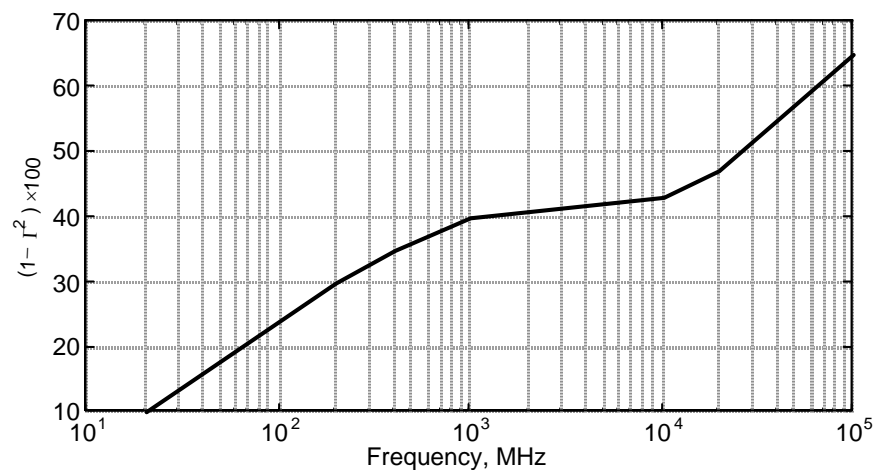

Electromagnetic Radiation Hazards (8)

Historical note on the industrial, scientific, and measurement (ISM) band (2.45 GHz):

The small skin depth at 2.45 GHz implies that the energy transfer between the wave and body occurs near the surface, and at these shallow depths the heat exchange mechanisms of the body are effective. Note that this is not a good frequency range for dosimetric (medical) applications because it is difficult to deposit energy deep into the body. The choice of the 2.45 GHz frequency for medical use was based on the erroneous conclusions of data collected by MIT in 1946. The study found that the absorption of water was 7000 times greater at this frequency than at the previously used 27 MHz and it was assumed that the therapeutic heating value would be much greater. Thus 2.45 GHz was adopted as a medical frequency before it was realized that the geometry and electrical properties of the body invalidated the study conclusion.

See A. Guy, "History of Biological Effects and Medical Applications of Microwave Energy," *IEEE Transactions on Microwave Theory and Techniques*, vol. 32, no. 9. September 1984.

Electromagnetic Radiation Hazards (9)

Various models are used in EM radiation and safety calculations. The simplest are spherical and monolithic models of a man. In general these dummy models are called phantoms.

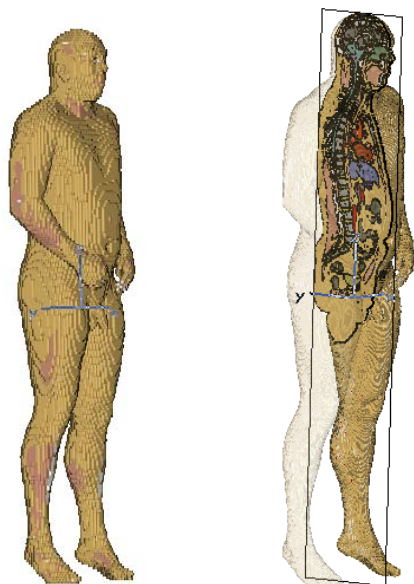

Complex phantom for use with the finite integration technique (CST *Microwave Studio*)

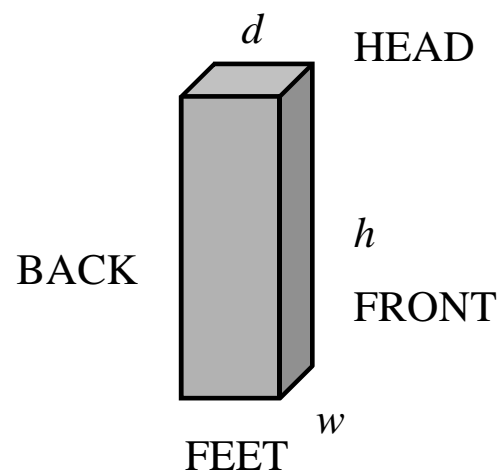

The monolithic model is a rectangular parallelepiped

Electromagnetic Radiation Hazards (10)

A sample calculation of whole body SAR for the monolithic model follows.

Dimensions: height (toe to head), $h=1.75$ m; width, (across shoulders) $w=0.45$ m; depth (chest to back), $d=0.25$ m (volume is 0.1969 m³). A height of 175 cm is the standard man.

The densities of fat and muscle are approximately 0.9 g/cm³ and 1.1 g/cm³, respectively. For convenience it is assumed that the average density of all body tissues is 1.0 g/cm³ yielding a mass of about 92 kg for the given dimensions.

For absorption calculations the following tissue parameters are used.

| Tissue | σ (S/m) | ϵ_r |
|-----------------------------|----------------|--------------|
| muscle (high water content) | 46 | 2.3 |
| fat (low water content) | 5.5 | 0.15 |

Electromagnetic Radiation Hazards (11)

The body is illuminated by an antenna with principal plane beamwidths θ_x and θ_y . At range R the area of the spot is an ellipse with axes $\ell_x = R\theta_x$ and $\ell_y = R\theta_y$. When the spot is larger than the body frontal area, the frontal area is used as the illuminated area; if the spot is smaller than the frontal area, the spot size determines the illuminated area. Therefore the illuminated area of the monolithic body is approximately

$$A_{\text{illum}} = \frac{\pi ab}{4} \quad \text{where } a = \min(\ell_x, w) \text{ and } b = \min(\ell_y, h)$$

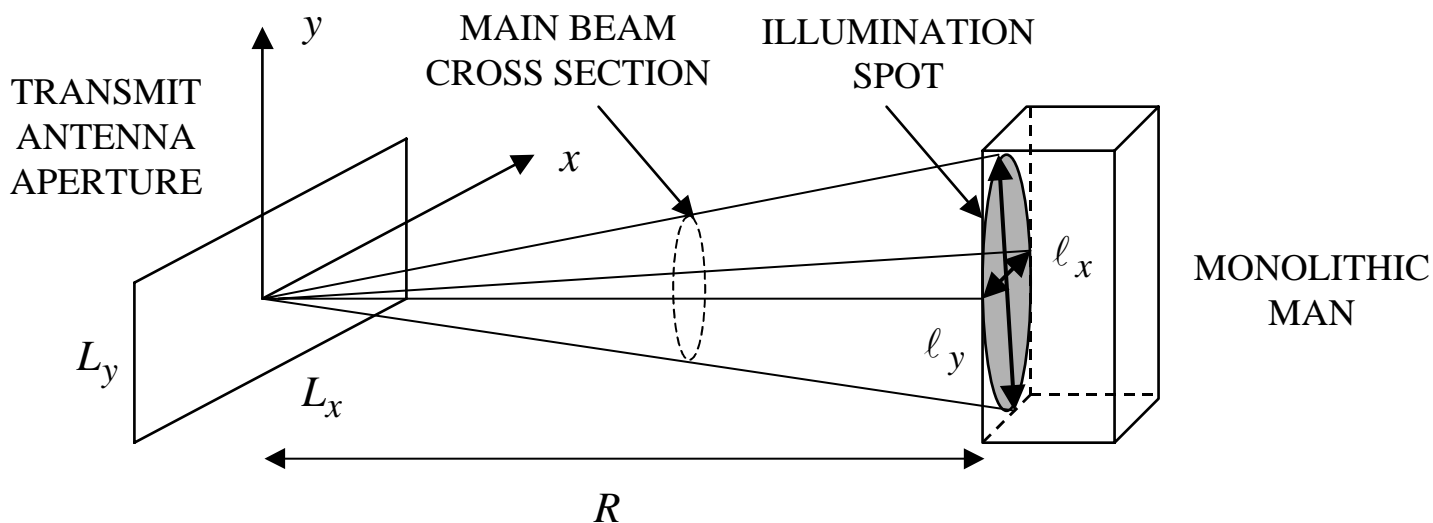

Electromagnetic Radiation Hazards (12)

For example, let the aperture dimensions be $L_x = 20\text{m}$ and $L_y = 2\text{m}$. Referring to the figure, the spot size at 50 m is greater than the body frontal area below about 1.9 GHz. Above 1.9 GHz the antenna beam narrows with frequency and less of the body is illuminated.

The worst case whole body SAR occurs when the spot size is bigger than the body.

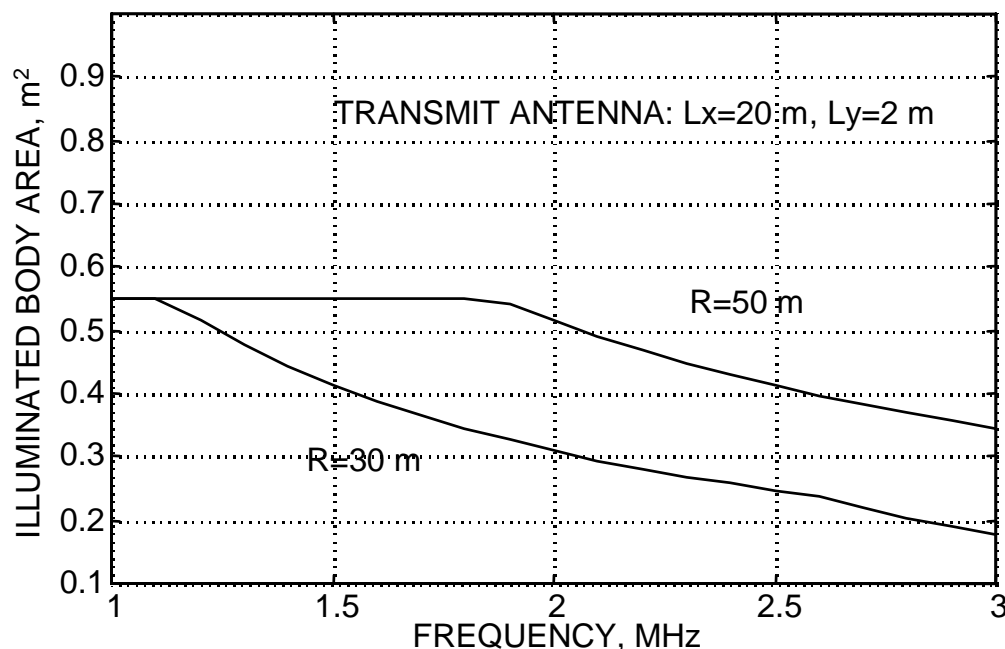

Electromagnetic Radiation Hazards (13)

For this calculation it is assumed that all of the incident field that is not reflected is absorbed

$$P_a = W_i wh(1 - |\Gamma|^2)$$

The reflection coefficient Γ is computed for a homogeneous slab of material (plot shown on p. 8)

$$\Gamma = \frac{\eta_i - 377}{\eta_i + 377}, \quad \eta_i = \frac{377 - \eta \tanh(\gamma d)}{\eta - 377 \tanh(\gamma d)}, \quad \eta = \sqrt{\frac{j\omega\mu}{\sigma + j\omega\epsilon_r\epsilon_o}}, \quad \gamma = \alpha + j\beta$$

η_i is the intrinsic impedance of the body of thickness d with free space on the back side. The incident power density, assuming the body is in the far field of the antenna, is

$$W_i = P_t G_t / (4\pi R^2)$$

The gain of the antenna with efficiency e is approximately related to the beamwidth by

$$G = 4\pi e L_x L_y / \lambda^2 \approx 4\pi e / (\theta_x \theta_y)$$

Electromagnetic Radiation Hazards (14)

For this example, another simplifying assumption is that the field in the body is approximately constant within the first skin depth and zero elsewhere. Thus all of the power is absorbed in the first skin depth of the body.

Sample values: $P_t = 100 \text{ W}$, $f = 1 \text{ GHz}$,
 $\delta = 0.023 \text{ m}$, $1 - |\Gamma|^2 = 0.4$ (from charts
 on p. 8), $R = 60 \text{ m}$ and $e = 0.7$

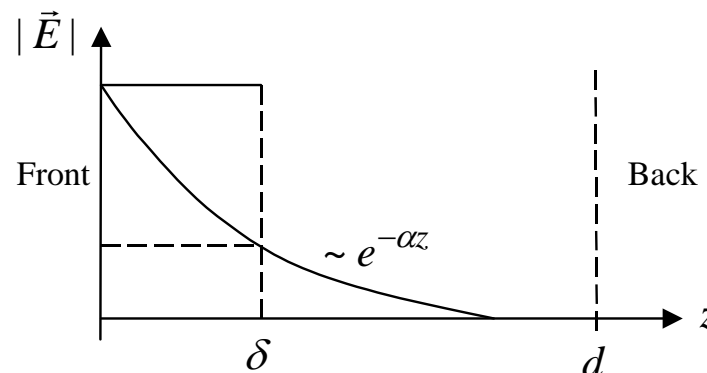

The incident power density is

$$W_i = P_t L_x L_y e / (\lambda R)^2 = \frac{(100)(20)(2)(0.7)}{(0.3)^2 (60)^2} = 8.64 \text{ W/m}^2 = 0.864 \text{ mW/cm}^2$$

which is safe ($< 10 \text{ mW/cm}^2$). For the present case, we use a SAR averaging volume of

$$V_a = wh\delta = 0.0101 \text{ m}^3.$$

Electromagnetic Radiation Hazards (15)

The heated body mass is

$$\rho V_a = \rho wh\delta = \left(1 \text{ gm/cm}^3 \times \frac{(100 \text{ cm})^3}{\text{m}^3} \times \frac{\text{kg}}{1000 \text{ gm}} \right) (0.0101 \text{ m}^3) = 10.1 \text{ kg}$$

and the SAR

$$\text{SAR} = \frac{P_a}{\rho V_a} = \frac{W_i wh(1 - |\Gamma|^2)}{\rho V_a} = \frac{(0.864)(0.25)(1.74)(0.4)}{10.1} = 0.1497 \text{ W/kg}$$

which is below the safe level of 0.4 W/kg. The SAR for 1 mW/cm² incident power density is shown at three frequencies and compared to data for other more detailed phantom models¹.

¹O. Gandhi, "State of the Knowledge for EM Absorbed Dose in Man and Animals," *Proceedings of the IEEE*, vol. 68, January 1980.

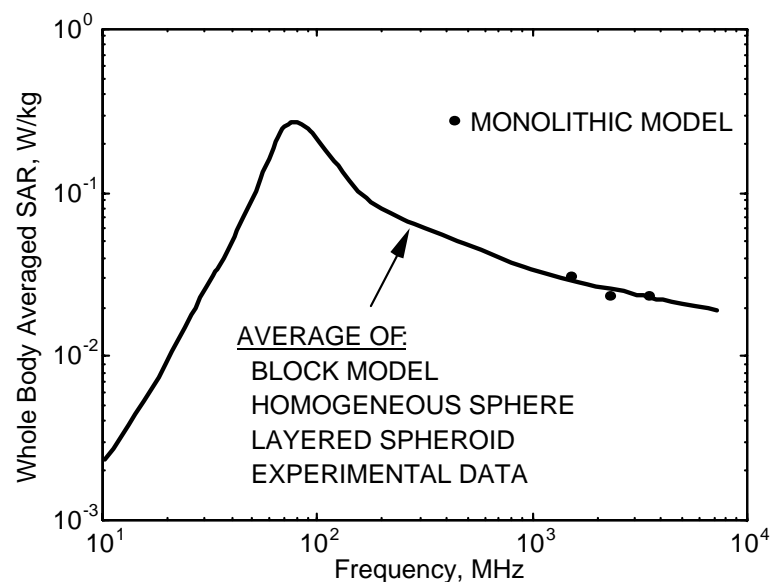

Cell Phone Base Station Exposure (1)

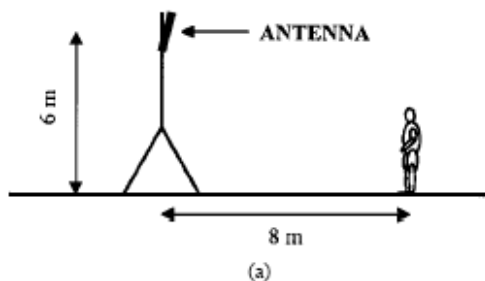

Case 1: subject on building roof

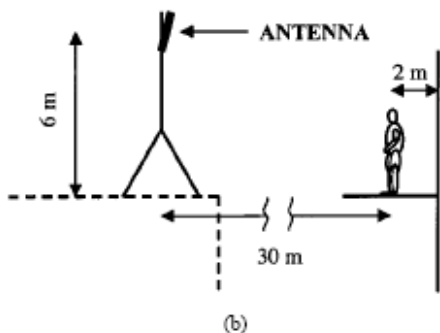

Case 2: subject on balcony

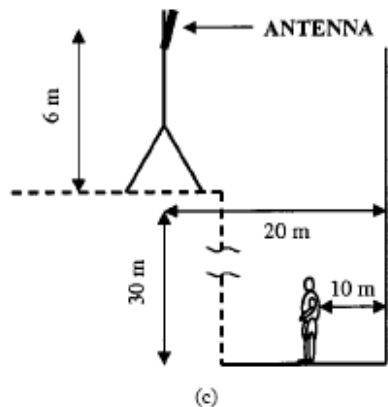

Case 3: subject on street

From "Human Exposure to Radio Base-Station Antennas in Urban Environments," *IEEE Trans. on MTT*, vol. 48, no. 11, Nov. 2000, p. 1996

Cell Phone Base Station Exposure (2)

- Frequency = 947.5 MHz (GSM)
- Finite Difference Time Domain (FDTD) method
- Antenna gain 14.7 dBi
- Horizontal HPBW = 80 degrees
- Vertical HPBW = 13 degrees
- Antenna tilted down from horizontal by 8 degrees

MAXIMUM SAR VALUES AVERAGED OVER 1 g (SAR_{1g}), OVER 10 g (SAR_{10g}), AND OVER THE WHOLE MASS (SAR_{WO}) OF THE MAIN BODY ORGANS FOR THE THREE EXPOSURE CONDITIONS CONSIDERED

SPATIAL MAXIMUM (E_{IMAX}), AND SPATIAL AVERAGE (E_{IAVE}), OF THE INCIDENT FIELD rms VALUE; MAXIMUM SAR VALUES AVERAGED OVER 1 g (SAR_{1g}), OVER 10 g (SAR_{10g}), AND SAR VALUE AVERAGED OVER THE WHOLE BODY (SAR_{WB}) FOR THE THREE EXPOSURE CONDITIONS CONSIDERED

| | E_{IMAX} (V/m) | E_{IAVE} (V/m) | SAR_{1g} (mW/kg) | SAR_{10g} (mW/kg) | SAR_{WB} (mW/kg) |
|-----------------|---------------------|---------------------|-----------------------|------------------------|-----------------------|
| Case I | 4.2 | 2.8 | 5.3 | 3.0 | 0.12 |
| Case II | 8.1 | 5.5 | 13.2 | 8.5 | 0.46 |
| Case III | 1.3 | 1.1 | 0.26 | 0.17 | 0.01 |

| | CASE I | | | CASE II | | | CASE III | | |
|-----------------|------------|-------------|------------|------------|-------------|------------|------------|-------------|------------|
| | SAR_{1g} | SAR_{10g} | SAR_{WO} | SAR_{1g} | SAR_{10g} | SAR_{WO} | SAR_{1g} | SAR_{10g} | SAR_{WO} |
| Brain | 1.38 | 0.72 | 0.33 | 2.71 | 1.40 | 0.63 | 0.13 | 0.07 | 0.04 |
| Eyes | 1.67 | - | 1.27 | 3.44 | - | 2.45 | 0.07 | - | 0.06 |
| Heart | 0.39 | 0.21 | 0.06 | 1.57 | 0.82 | 0.21 | 0.02 | 0.01 | < |
| Kidney | 0.04 | 0.01 | < | 0.13 | 0.03 | 0.03 | < | < | < |
| Liver | 0.51 | 0.27 | 0.05 | 1.42 | 0.79 | 0.17 | 0.03 | 0.02 | < |
| Pancreas | 0.10 | - | 0.03 | 0.35 | - | 0.10 | 0.01 | - | < |
| Spleen | 0.06 | 0.01 | 0.01 | 0.14 | 0.07 | 0.04 | 0.01 | < | < |
| Testis | 0.80 | - | 0.41 | 2.31 | - | 1.10 | 0.04 | - | 0.02 |

SAR is in mW/kg.
 "<" means less than 0.01.

Cell Phone Base Station Exposure (3)

Data for Case II

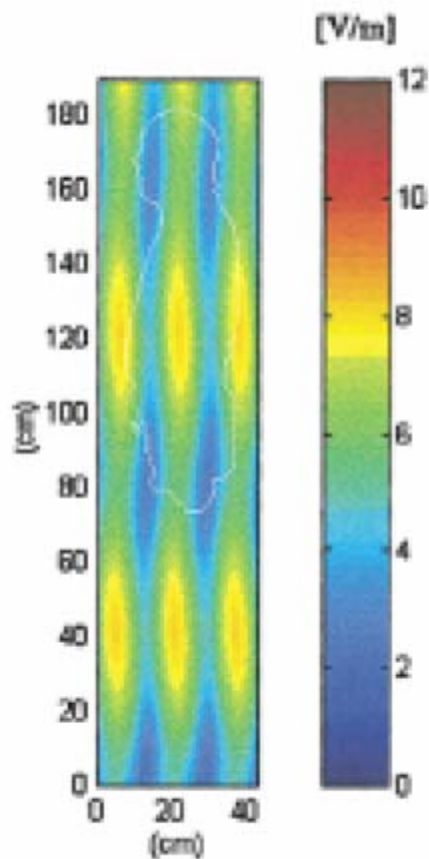

E_{rms} no subject present

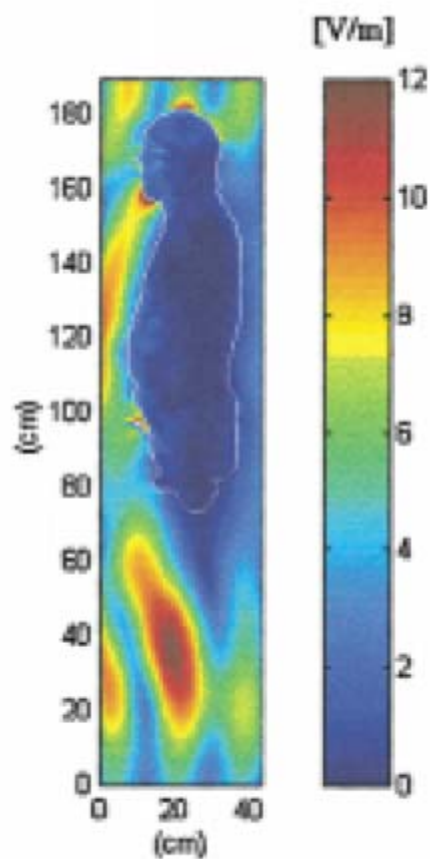

E_{rms} with subject present

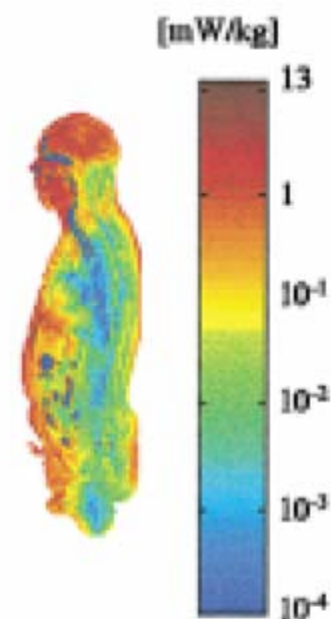

SAR inside of subject

Cell Phone Exposure (1)

From “Specific Absorption Rate and Temperature Increases in the Head of a Cellular-Phone User,” *IEEE Trans. on MTT*, vol. 48, no. 7, July, 2000, p. 1118

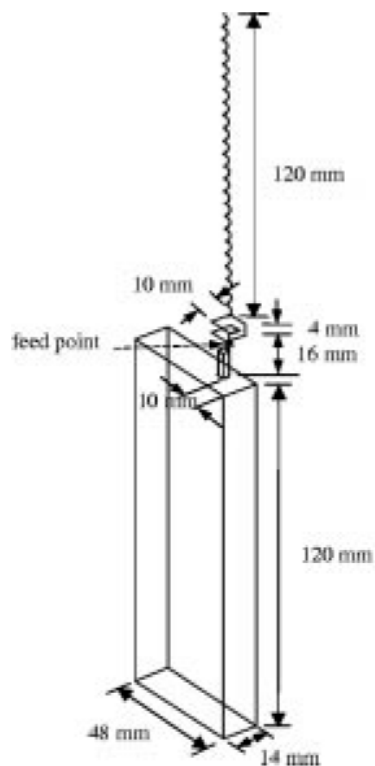

Whip antenna

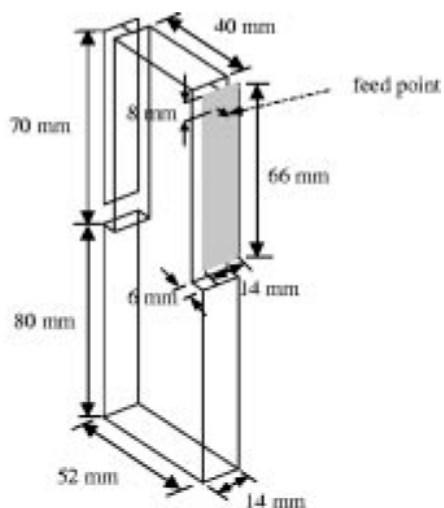

Side-mounted patch

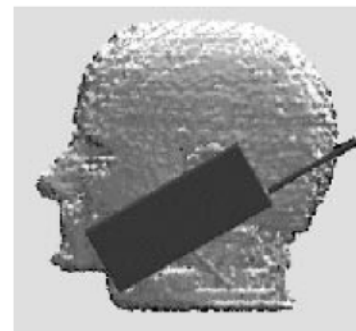

MASS DENSITY AND DIELECTRIC PARAMETERS OF THE HEAD TISSUES AT 900 MHz

| | ρ [kg/m ³] | ϵ_r | σ [S/m] |
|---------------|-----------------------------|--------------|----------------|
| Skin | 1010 | 41.4 | 0.87 |
| Muscle | 1040 | 55.0 | 0.94 |
| Bone | 1810 | 21.0 | 0.32 |
| Blood | 1060 | 61.4 | 1.54 |
| Fat | 920 | 11.3 | 0.11 |
| Cartilage | 1100 | 40.8 | 0.81 |
| Grey matter | 1040 | 54.7 | 1.19 |
| White matter | 1040 | 35.7 | 0.61 |
| Humor | 1010 | 74.1 | 1.97 |
| Lens | 1100 | 51.3 | 0.89 |
| Sclera/Cornea | 1170 | 52.1 | 1.22 |
| Cerebellum | 1040 | 49.6 | 1.03 |
| Hypophysis | 1040 | 49.6 | 1.03 |
| CSF | 1010 | 74.0 | 2.12 |
| Parotid | 1040 | 49.6 | 1.03 |
| Tongue | 1040 | 57.0 | 0.80 |

Cell Phone Exposure (2)

TOTAL POWER ABSORBED IN THE HEAD (P_{abs}), MAXIMUM SAR AS AVERAGED OVER 1g (SAR_{1MAX}) AND 10g (SAR_{10MAX}) OF TISSUE IN THE HEAD, AND MAXIMUM SAR AS AVERAGED OVER 1g OF BRAIN ($SAR_{1MAXbrain}$) OR EYE ($SAR_{1MAXeye}$). PHONE POSITIONS: VERTICAL (V) AND TILTED (T). POWER RADIATED IN FREE SPACE: 600 mW. FREQUENCY: 900 MHz

| Phone model | | P_{abs} [mW] | SAR_{1MAX} [W/kg] | SAR_{10MAX} [W/kg] | $SAR_{1MAXbrain}$ [W/kg] | $SAR_{1MAXeye}$ [W/kg] |
|---|---|-------------------|------------------------|-------------------------|-----------------------------|---------------------------|
| WHIP | V | 313 | 2.30 | 1.14 | 0.93 | 0.033 |
| | T | 272 | 2.31 | 1.25 | 0.66 | 0.059 |
| MONOPOLE | V | 365 | 2.17 | 1.29 | 1.21 | 0.022 |
| | T | 323 | 2.40 | 1.29 | 0.73 | 0.077 |
| DIPOLE | V | 388 | 2.74 | 1.93 | 1.85 | 0.022 |
| | T | 323 | 2.83 | 1.08 | 0.81 | 0.015 |
| PIFA (Side mounted- frontal patch fed) | V | 428 | 3.72 | 1.88 | 1.22 | 0.071 |
| | T | 402 | 3.40 | 1.99 | 1.28 | 0.165 |

STEADY-STATE TEMPERATURE RISE. MAXIMUM IN THE WHOLE HEAD (ΔT_{MAX}), IN THE BRAIN ($\Delta T_{MAXbrain}$), AND IN THE LENS ($\Delta T_{MAXlens}$). PHONE POSITIONS: VERTICAL (V) AND TILTED (T). POWER RADIATED IN FREE SPACE: 600 mW. FREQUENCY: 900 MHz

| Phone model | | ΔT_{MAX} [°C] | $\Delta T_{MAXbrain}$ [°C] | $\Delta T_{MAXlens}$ [°C] |
|---|---|--------------------------|-------------------------------|------------------------------|
| WHIP | V | 0.23 | 0.12 | 0.005 |
| | T | 0.25 | 0.08 | 0.008 |
| MONOPOLE | V | 0.22 | 0.13 | 0.003 |
| | T | 0.23 | 0.09 | 0.010 |
| DIPOLE | V | 0.33 | 0.19 | 0.003 |
| | T | 0.29 | 0.13 | 0.002 |
| PIFA (Side mounted- frontal patch fed) | V | 0.43 | 0.14 | 0.011 |
| | T | 0.39 | 0.16 | 0.022 |

Cell Phone Exposure (3)

- “Whip” phone
- 600 mW radiated in free space
- FDTD method

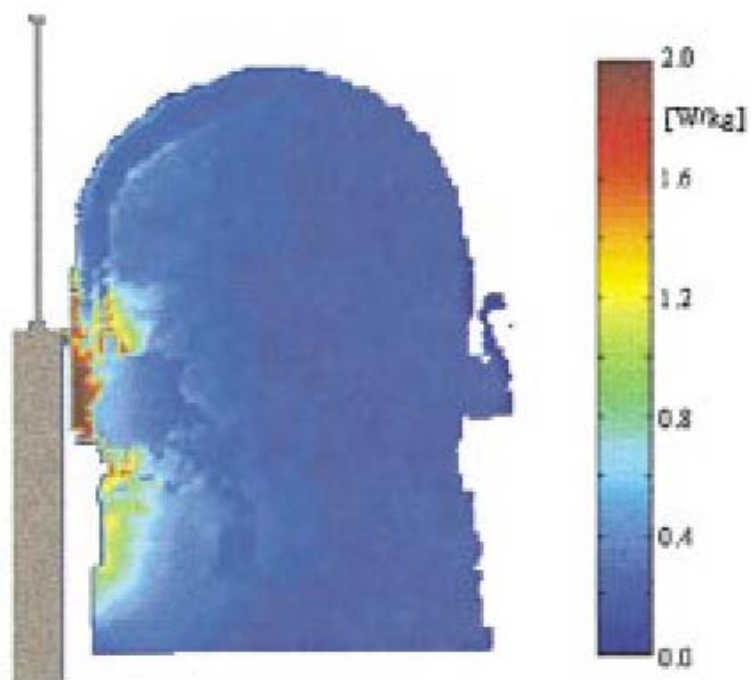

SAR

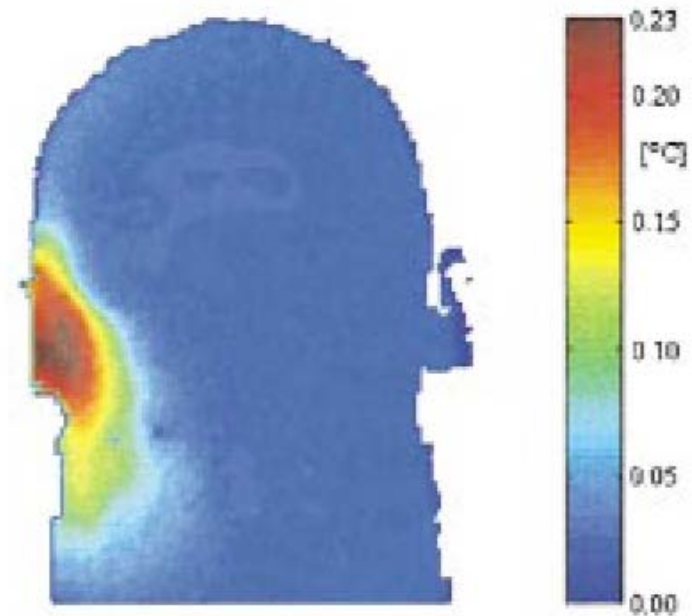
 ΔT